



Die Components
Normalien
Componenti

PSA
—
GROUPE

OMCR[®]
STANDARD DIE COMPONENTS



<p>E24.51.930.G</p>  <p>Balance block Distanzstück Distanziale</p> <p>485</p>	<p>E24.51.930.G</p>  <p>Stop block Abstandsblock Distanziale</p> <p>485</p>	<p>E24.52.105.G</p>  <p>Guide post Führungssäule Colonna</p> <p>486</p>	<p>E24.52.105.G</p>  <p>Anfor Clamping Flange Spannflansch Anfor Ritegno Per Colonna Anfor</p> <p>487</p>	<p>E24.52.105.G</p>  <p>Anfor Retaining Flange Sicherungsflansch Anfor Ritegno Anfor</p> <p>487</p>
<p>E24.52.105.G</p>  <p>Guide post Führungssäule Colonna</p> <p>488</p>	<p>E24.52.105.G</p>  <p>Bush self-lubricating Führungsbuchse Boccola autolubrificante</p> <p>489</p>	<p>E24.52.105.G</p>  <p>Toe clamp for bush Haltestück für Buchse Ritegno per boccola</p> <p>490</p>	<p>E24.52.305.G</p>  <p>Toe clamp for bush Haltestück für Buchse Ritegno per boccola</p> <p>490</p>	<p>E24.52.504.G</p>  <p>Wear plate VDI 3357 Gleitplatte VDI 3357 Piastra guida VDI 3357</p> <p>491</p>
<p>E24.52.504.G</p>  <p>Wear plate VDI 3357 Gleitplatte VDI 3357 Piastra guida VDI 3357</p> <p>492</p>	<p>E24.52.504.G</p>  <p>Wear plate Anfor Gleitplatte Anfor Piastra guida Anfor</p> <p>493</p>	<p>E24.52.504.G</p>  <p>Wear Plate Anfor Gleitplatte Anfor Piastra guida Anfor</p> <p>494</p>	<p>E24.52.535.G</p>  <p>Wear plate Gleitplatte Piastra guida</p> <p>495</p>	<p>E24.52.535.G</p>  <p>Wear plate Gleitplatte Piastra guida</p> <p>495</p>
<p>E24.54.410.G</p>  <p>Elastomer spring Elastomerfeder Molla in elastomero</p> <p>496</p>	<p>E24.54.410.G</p>  <p>Elastomer Spring Pin Aufnahmebolzen Perno per molle</p> <p>496</p>	<p>E24.54.420.G</p>  <p>Elastomer cap Elastomerdruckstück Puntalino in elastomero</p> <p>497</p>	<p>E24.55.265.G</p>  <p>Shock absorber Halteelemente Ammortizzatore</p> <p>497</p>	<p>E24.55.265.G</p>  <p>Retainer pin Steckbolzen Perno di arresto</p> <p>498</p>

<p>E24.56.200.G</p>  <p>Gage hardened Einweiser gehärtet Riferimento indurito</p> <p>498</p>	<p>E24.56.200.G</p>  <p>Gage for sensor Einweiser für Teillagekontrolle Riferimento per sensore</p> <p>499</p>	<p>E24.56.630.G</p>  <p>Key Passfedern Chiavetta</p> <p>500</p>	<p>E24.56.630.G</p>  <p>Key Passfedern Chiavetta</p> <p>501</p>	<p>E24.56.700.G</p>  <p>Locating cone Kegeldistanz Cono di centraggio</p> <p>502</p>
<p>E24.57.370.G</p>  <p>Sleeve Führungseinheit Canotto Guida</p> <p>502</p>	<p>E24.57.370.G</p>  <p>Clamp Befestigungselement Morsetto</p> <p>503</p>	<p>E24.57.370.G</p>  <p>Lifting column Führungssäule für Heber Colonna per sollevatore</p> <p>503</p>	<p>E24.57.370.G</p>  <p>Union block Befestigungselement Tassello di unione</p> <p>504</p>	<p>E24.57.370.G</p>  <p>Clevis Gabelförmig Forcella</p> <p>504</p>
<p>E24.64.100.G</p>  <p>Stamp retainer Halteplatte Portatimbri</p> <p>505</p>	<p>E24.64.100.G</p>  <p>Backing plate Druckplatte Distanziale</p> <p>505</p>	<p>E24.64.100.G</p>  <p>Stamp Buchstabenstempel Punzone marchio</p> <p>506</p>	<p>E24.64.100.G</p>  <p>Stamp Buchstabenstempel Punzone marchio</p> <p>506</p>	<p>E24.64.110.G</p>  <p>Stamp retainer Halteplatte Portatimbri</p> <p>507</p>
<p>E24.65.000.G</p>  <p>Lifting pin Tragbolzen mit Fallringsicherung Perno di sollevamento</p> <p>508</p>				



BALANCE BLOCK - DISTANZSTÜCK - DISTANZIALE

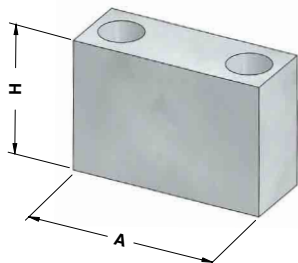

Notes

Material: CK45

STOCK



PSA CODE

A 699 101 804

PSA CODE	A	H
A 699 101 605	80	55
A 699 101 804	110	55
J 856 750 087	100	137
J 859 912 001	80	101

Standard PSA

STOP BLOCK - ABSTANDBLOCK - DISTANZIALE

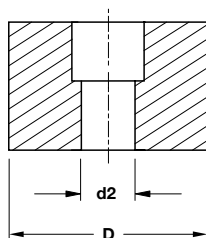
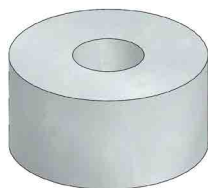

Notes

Material: 25CrMo4

HRC: 240÷300

STOCK



PSA CODE

N 001 107 798

PSA CODE	OMCR CODE	D	d2
N 001 107 798	A08070030M12	70	13
N 001 796 935	A08070030M08	70	9
N 001 107 801	A08040020M12	40	13

GUIDE POST - FÜHRUNGSSÄULE - COLONNA



Notes

- 1** Material: Steel - HRC: 60±62
- 2** Material: St37

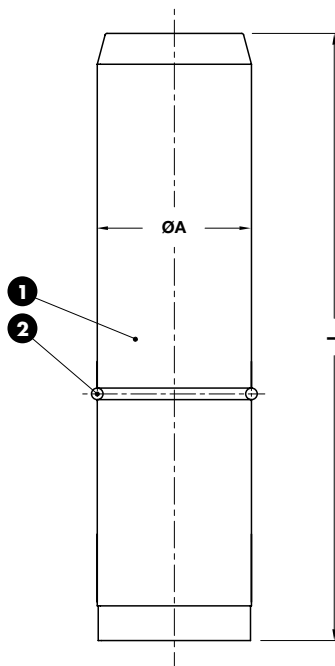

PSA CODE

Z 000 495 749

PSA CODE	A	L	PSA CODE	A	L
Z 000 115 378	25	100	P 446 118 170	50	220
Z 000 495 749	25	125	P 446 118 174	50	250
Z 000 306 386	32	125	P 446 118 101	50	280
Z 000 325 846	32	220	P 446 118 701	63	250
P 446 117 470	40	180	P 446 118 702	63	315
P 446 117 401	40	200	P 446 119 200	80	315
P 446 117 476	40	220	P 446 119 270	80	355

AFNOR CLAMPING FLANGE - SPANNFLANSCH AFNOR - RITEGNO PER COLONNA AFNOR

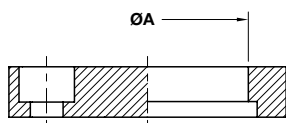
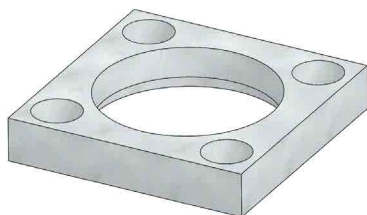

Notes

Material: CK45

STOCK



PSA CODE
P 446 932 711

PSA CODE	A
Z 000 248 844	25
P 446 932 711	32
P 446 932 701	40
P 446 932 702	50
P 446 932 703	63
P 446 932 704	80

Standard PSA

AFNOR RETAINING FLANGE - SICHERUNGSFLANSCH AFNOR - RITEGNO AFNOR

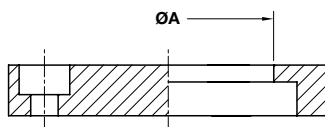
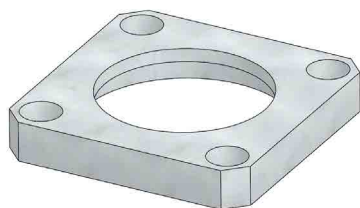

Notes

Material: CK45

STOCK



PSA CODE
P 446 932 720

PSA CODE	A
P 446 932 719	50
P 446 932 720	60
P 446 932 721	80
P 446 932 722	100

GUIDE POST - FÜHRUNGSSÄULE - COLONNA

Notes

Material: Steel - **HRC:** 60+62

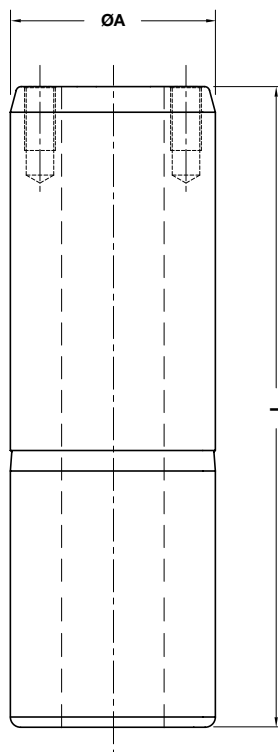
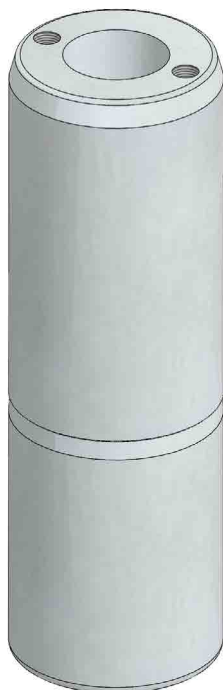

PSA CODE

N 000 829 460

PSA CODE	A	L	PSA CODE	A	L
N 000 622 562	100	280	Z 000 499 647	100	355
N 000 829 460	100	250	Z 000 508 422	100	400
Z 000 508 424	100	315			

BUSH SELF-LUBRICATING - FÜHRUNGSBUCHSE - BOCCOLA AUTOLUBRIFICANTE

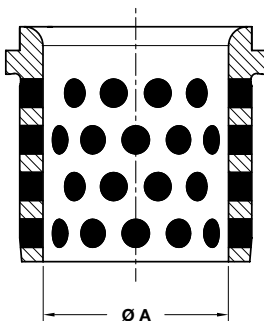

Notes

Material: Bronze + Graphite
HB > 190

STOCK



PSA CODE
Z 000 499 644

PSA CODE	A
Z 000 499 644	100

Standard PSA

TOE CLAMP FOR BUSH - HALTESTÜCK FÜR BUCHSE - RITEGNO PER BOCCOLA

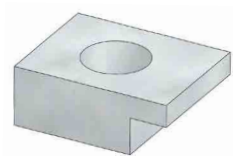

Notes

Material: CK45

STOCK

Application example

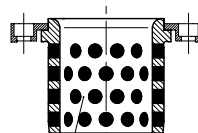

E24.52.105.G



PSA CODE
Z 000 263 005

PSA CODE
Z 000 263 005

TOE CLAMP FOR BUSH - HALTESTÜCK FÜR BUCHSE - RITEGNO PER BOCCOLA

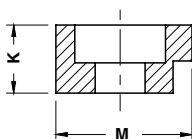

Notes

Material: CK45

STOCK



PSA CODE
P 446 932 708

PSA CODE	K	M
P 446 932 706	9	18
P 446 932 708	11	22
P 446 932 709	18	26

WEAR PLATE SELF-LUBRICATING VDI 3357
GLEITPLATTE BRONZE MIT FESTSCHMIERSTOFF VDI 3357
PIASTRA GUIDA AUTOLUBRIFICANTE VDI 3357

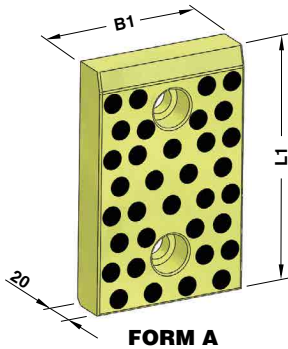

FORM A

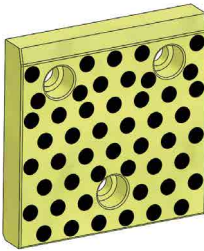

FORM B

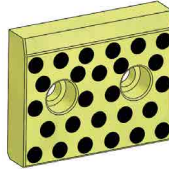

FORM C

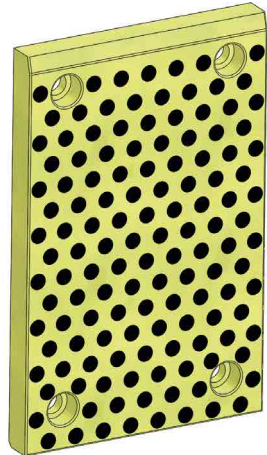

FORM D

Notes
Material: Bronze + Graphite
HB > 190



Standard PSA

ORDER EXAMPLE	PSA CODE
	N 001 275 075

* Not in accordance with VDI3357
 Nicht mit Entspricht VDI3357
 Non conforme alla norma VDI3357

PSA CODE	B1	L1	FORM	PSA CODE	B1	L1	FORM
N 001 337 331	50	80	A	N 001 275 175	100	160	A
N 001 275 075	50	100	A	N 001 275 176	100	200	A
N 001 275 076	50	125	A	N 001 275 436*	100	250	D
N 001 275 095	50	160	A	N 001 275 195	125	80	C
N 001 275 096	50	200	A	N 001 275 215	125	100	B
N 001 334 791	80	50	C	N 001 275 235	125	125	B
N 001 337 333	80	80	A	N 001 275 236	125	160	B
N 001 275 115	80	100	A	N 001 275 255	125	200	B
N 001 275 135	80	125	A	N 001 275 256	160	100	B
N 001 275 136	80	160	A	N 001 275 257	160	125	B
N 001 275 137	80	200	A	N 001 275 295	160	160	B
N 001 275 138	100	50	C	N 001 275 437*	160	200	D
N 001 275 139	100	80	C	N 001 275 438*	160	250	D
N 001 275 155	100	100	A	N 001 275 439*	160	300	D
N 001 275 156	100	125	A				

WEAR PLATE STEEL VDI 3357
GLEITPLATTE STAHL VDI 3357
PIASTRA GUIDA IN ACCIAIO VDI 3357

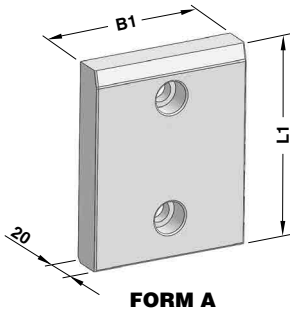

Notes

Material: 16MnCr5
HRC: 58÷60

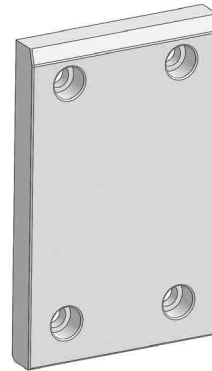
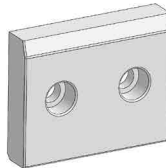
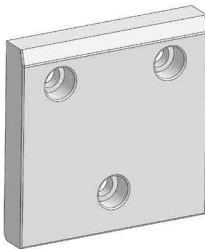

	PSA CODE
	N 001 275 495

* Not in accordance with VDI3357
 entspricht nicht VDI3357
 Non conforme alla linea guida VDI3357

PSA CODE	B1	L1	FORM	PSA CODE	B1	L1	FORM
N 001 337 327	50	80	A	N 001 275 617	100	160	A
N 001 275 495	50	100	A	N 001 275 618	100	200	A
N 001 275 496	50	125	A	N 001 276 057*	100	250	D
N 001 275 497	50	160	A	N 001 275 635	125	80	C
N 001 275 515	50	200	A	N 001 275 655	125	100	B
N 001 334 794	80	50	C	N 001 275 656	125	125	B
N 001 337 329	80	80	A	N 001 275 675	125	160	B
N 001 275 535	80	100	A	N 001 275 676	125	200	B
N 001 275 536	80	125	A	N 001 275 677	160	100	B
N 001 275 537	80	160	A	N 001 275 695	160	125	B
N 001 275 555	80	200	A	N 001 275 696	160	160	B
N 001 275 575	100	50	C	N 001 276 058*	160	200	D
N 001 275 595	100	80	C	N 001 276 059*	160	250	D
N 001 275 615	100	100	A	N 001 275 762*	160	300	D
N 001 275 616	100	125	A				

WEAR PLATE SELF-LUBRICATING AFNOR
GLEITPLATTE BRONZE MIT FESTSCHMIERSTOFF AFNOR
PIASTRA GUIDA AUTOLUBRIFICANTE AFNOR

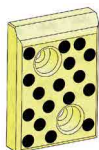

FORM A

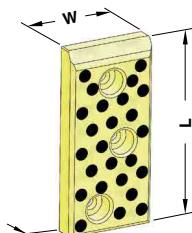

FORM B

Notes

Material: Bronze + Graphite
HB > 190
 Only for replacement
 Nur für Reparatur
 Solo per riparazione

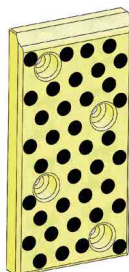

FORM C

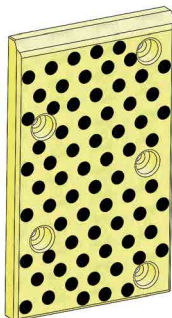

FORM E



FORM F

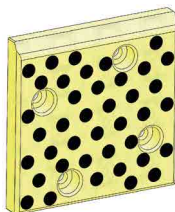

FORM D

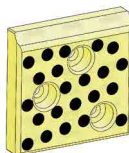

FORM G

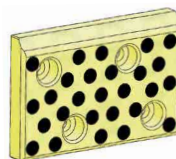

FORM H

ORDER EXAMPLE	PSA CODE
	Z 000 166 216

PSA CODE	W	L	FORM	PSA CODE	W	L	FORM
Z 000 166 214	70	100	A	Z 000 166 227	100	300	F
Z 000 166 216	70	150	B	Z 000 166 218	150	100	H
Z 000 166 221	70	200	C	Z 000 166 219	150	150	D
Z 000 166 215	100	100	G	Z 000 166 223	150	200	C
Z 000 166 217	100	150	D	Z 000 166 226	150	250	E
Z 000 166 222	100	200	C	Z 000 166 228	150	300	F
Z 000 166 225	100	250	E	Z 000 166 224	200	100	H

Standard PSA

WEAR PLATE STEEL AFNOR GLEITPLATTE STAHL AFNOR PIASTRA GUIDA IN ACCIAIO AFNOR

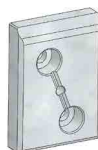

FORM A

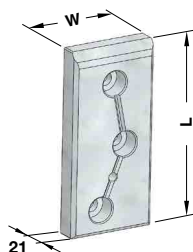

FORM B

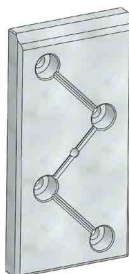

FORM C

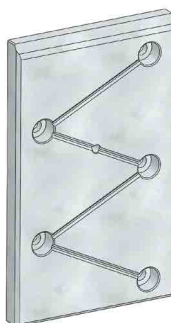

FORM E

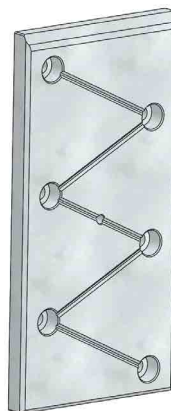

FORM F

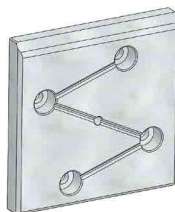

FORM D

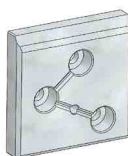

FORM G

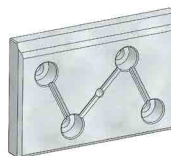

FORM H

Notes

Material: 16MnCr5
HRC: 58÷60
 Only for replacement
 Nur für Reparatur
 Solo per riparazione



PSA CODE
P 446 626 558

PSA CODE	W	L	FORM	PSA CODE	W	L	FORM
Z 000 166 213	70	100	A	P 446 627 754	100	300	F
P 446 626 558	70	150	B	P 446 626 560	150	100	H
P 446 627 059	70	200	C	P 446 626 561	150	150	D
P 446 625 855	100	100	G	P 446 627 061	150	200	C
P 446 626 559	100	150	D	P 446 627 455	150	250	E
P 446 627 060	100	200	C	P 446 627 755	150	300	F
P 446 627 454	100	250	E	Z 000 166 220	200	100	H

WEAR PLATE SELF-LUBRICATING
GLEITPLATTE BRONZE MIT FESTSCHMIERSTOFF
PIASTRA GUIDA AUTOLUBRIFICANTE

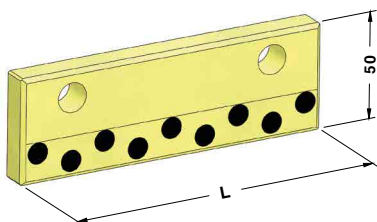
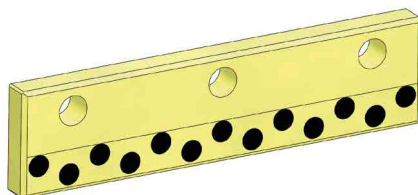
**Notes**

Material: Bronze + Graphite
HB > 190

STOCK



PSA CODE	N 000 577 043
----------	---------------

PSA CODE	L
N 000 577 042	200
N 000 577 043	150

WEAR PLATE SELF-LUBRICATING
GLEITPLATTE BRONZE MIT FESTSCHMIERSTOFF
PIASTRA GUIDA AUTOLUBRIFICANTE

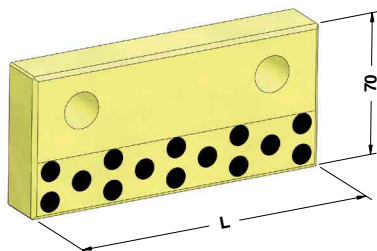
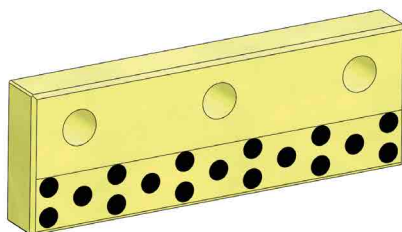
**Notes**

Material: Bronze + Graphite
HB > 190

STOCK



PSA CODE	N 000 577 047
----------	---------------

PSA CODE	L
N 000 577 046	200
N 000 577 047	150

ELASTOMER SPRING - ELASTOMERFEDER - MOLLA IN ELASTOMERO

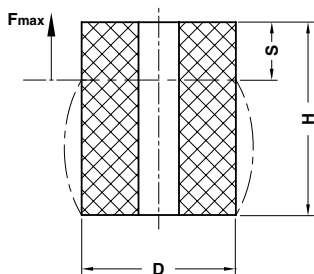

S = max. 30% H

Notes
Material: Polyurethane 90 SH

STOCK

ORDER EXAMPLE 	PSA CODE
	X 346 552 171

PSA CODE	D	H	Fmax (daN)	PSA CODE	D	H	Fmax (daN)	PSA CODE	D	H	Fmax (daN)
X 346 552 172	16	20	130	Z 000 163 783	40	32	1250	X 346 555 572	80	80	4300
X 346 552 171	16	25	130	X 346 553 871	40	63	1250	Z 000 163 271	80	100	4300
X 346 552 670	20	25	200	X 346 554 700	50	40	1700	X 346 555 570	80	125	4300
X 346 552 671	20	32	200	X 346 554 772	50	50	1700	X 346 555 372	100	80	5900
Z 000 163 267	25	20	300	X 346 554 770	50	80	1700	X 346 555 373	100	100	5900
X 346 553 173	25	32	300	X 346 554 703	50	100	1700	X 346 555 578	100	125	5900
Z 000 263 907	25	40	300	Z 000 163 269	63	40	2600	Z 000 163 272	125	100	9900
Z 000 163 268	32	40	580	Z 000 163 270	63	80	2600	X 346 556 305	125	160	9900

ELASTOMER SPRINGS PIN - AUFNAHMEBOLZEN - PERNO PER MOLLE IN ELASTOMERO

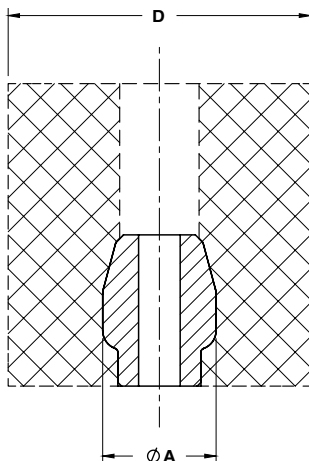

Notes
Material: CK45

STOCK

ORDER EXAMPLE 	PSA CODE
	G 856 699 005

PSA CODE	A	D
G 856 699 010	25	50÷63
G 856 699 005	30	80÷100
G 856 699 002	38	125

ELASTOMER CAP - ELASTOMERDRUCKSTÜCK - PUNTALINO IN ELASTOMERO

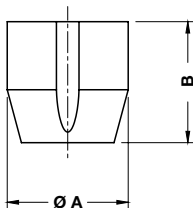
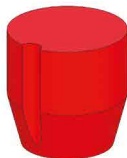

Notes

Material: Elastomer 92 SH

STOCK

ORDER EXAMPLE 	PSA CODE	
	P 399 341 501	

PSA CODE	A	B
P 399 341 500	6	9,5
P 399 341 501	10	15,5
P 399 341 502	16	25
P 399 341 700	24	25

Standard PSA

SHOCK ABSORBER - HALTELEMENTE - AMMORTIZZATORE

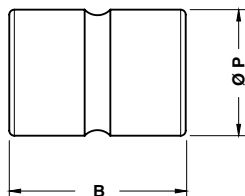

Without silicone
Ohne silicon
Senza silicone

Notes

Material: Elastomer 92 SH

STOCK

ORDER EXAMPLE 	PSA CODE	
	Z 000 404 676	

PSA CODE	B	P
Z 000 404 675	45	25
Z 000 404 676	50	32
X 346 563 970	60	40
Z 000 404 677	70	50
X 346 564 970	80	63
Z 000 404 678	90	80

RETAINER PIN - STECKBOLZEN - PERNO DI ARRESTO

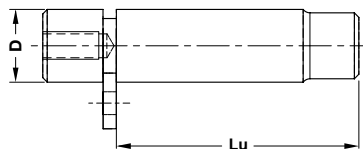
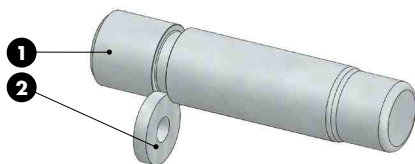

Notes

1 2 Material: CK45



ORDER EXAMPLE 	PSA CODE
	Z 000 400 338

PSA CODE	D	Lu	PSA CODE	D	Lu	PSA CODE	D	Lu
Z 000 400 337	20	81	Z 000 400 342	32	148	Z 000 400 350	50	220
Z 000 400 338	25	81	Z 000 400 345	40	132	Z 000 400 353	63	210
Z 000 400 339	25	98	Z 000 400 346	40	192	Z 000 400 354	63	250
Z 000 400 487	32	103	Z 000 400 349	50	165	Z 000 424 846	80	210

GAGE HARDENED - EINWEISER GEHÄRTET - RIFERIMENTO INDURITO

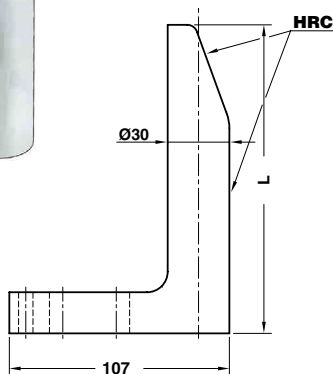
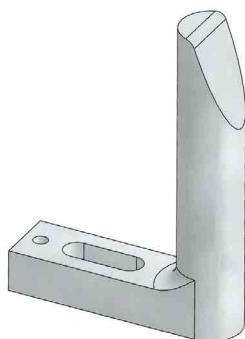

Notes

Material: CK60 - HRC: 58÷60



ORDER EXAMPLE 	PSA CODE
	N 000 445 401

PSA CODE	L
N 000 445 400	65
N 000 445 401	90
N 000 445 402	120
N 000 445 403	150
N 000 445 404	180
N 000 445 405	250

GAGE FOR SENSOR - EINWEISER FÜR TEILLAGEKONTOLLE - RIFERIMENTO PER SENSORE

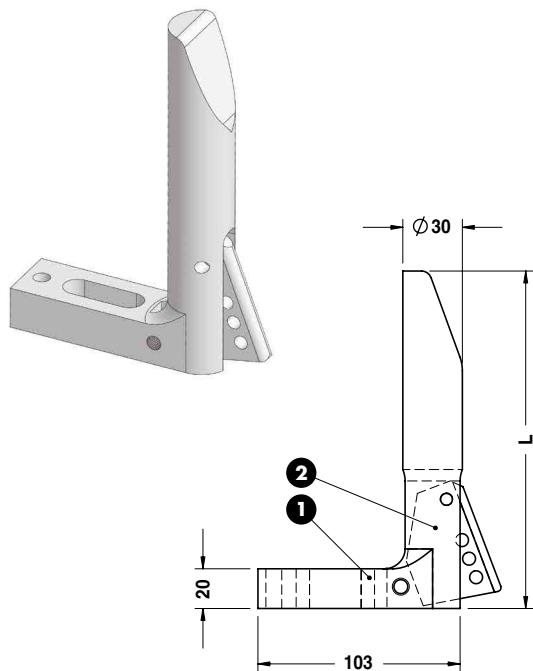

Notes

- ① Material: CK60
 ② Material: St37 - HRC: 58÷60



ORDER EXAMPLE	PSA CODE	
	N 001 281 615	
	PSA CODE	L
	N 001 281 595	120
	N 001 281 615	150
	N 001 281 635	180
	N 001 281 655	250

KEY - PASSFEDERN - CHIAVETTA

Notes

Material: CK45
 Only for replacement
 Nur für Reparatur
 Solo per riparazione

STOCK

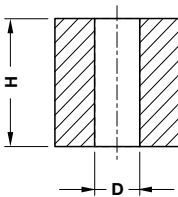
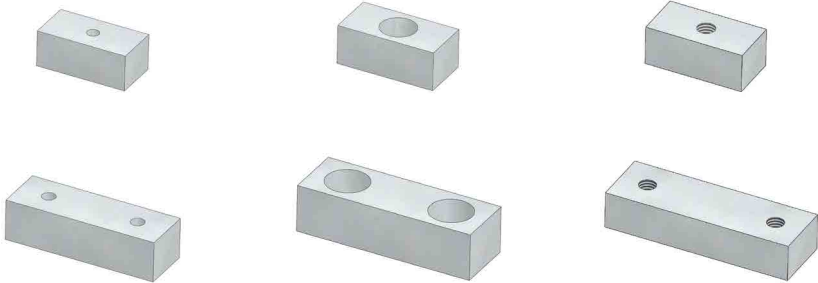

FORM A

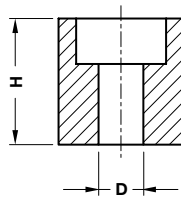

FORM B

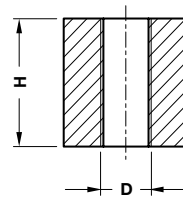

FORM C



PSA CODE

J 859 623 008

PSA CODE	H	Nr. hole	D	FORM	PSA CODE	H	Nr. hole	D	FORM
X 548 292 170	20	1	9	A	J 859 623 002	25	2	M8	C
J 859 623 008	25	1	9	A	J 859 623 006	25	1	M10	C
X 548 299 870	32	2	11	A	J 859 623 007	25	2	M10	C
J 859 623 003	25	1	9	B	J 859 623 011	32	1	M8	C
J 859 623 004	25	2	9	B	J 859 623 012	32	2	M8	C
J 859 623 013	32	1	9	B	J 859 623 016	32	1	M10	C
J 859 623 014	32	2	9	B	J 859 623 017	32	2	M10	C
J 859 623 001	25	1	M8	C					

KEY - PASSFEDERN - CHIAVETTA

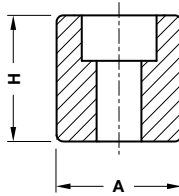
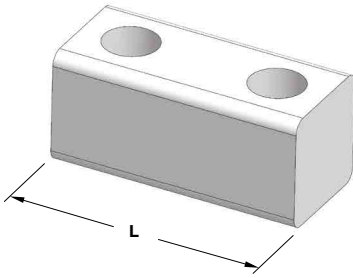

Notes

Material: 16MnCr5 - **HRC:** 60÷62

STOCK



PSA CODE			
N 001 327 512			

PSA CODE	A	H	L
N 001 327 511	45 h6	45	100
N 001 327 512	45 h6	45	200

Standard PSA

LOCATING CONE - KEGELDISTANZ - CONO DI CENTRAGGIO

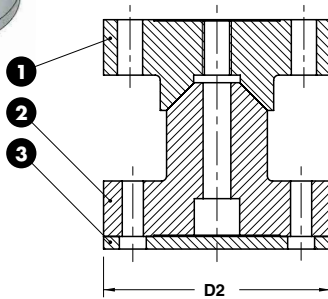
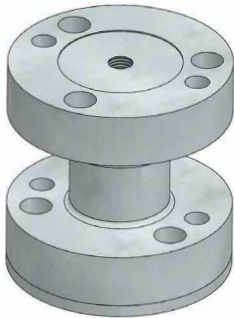

Notes

1 2

Material: X155CrMo12 - HRC: 58±60

3 **Material:** 36CrNiMo4

STOCK



PSA CODE

Z 000 400 140

PSA CODE

D2

Z 000 400 139

90

Z 000 400 140

110

SLEEVE - FÜHRUNGSEINHEIT - CANOTTO GUIDA

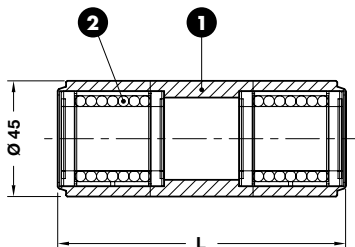
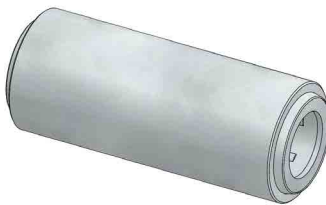

Notes

1 **Material:** CK45

2 STAR 0658-225-40

STOCK



PSA CODE

P 446 905 006

PSA CODE

L

P 446 905 005

112

P 446 905 006

200

CLAMP - BEFESTIGUNGSELEMENT - MORSETTO

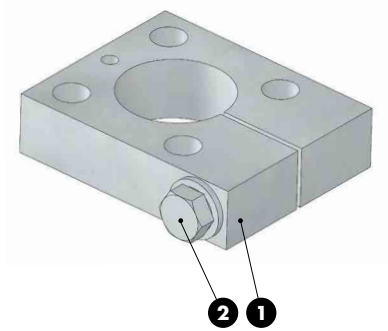

Notes	
1	Material: CK45
2	M12x70 DIN 931



ORDER EXAMPLE	PSA CODE
	P 446 932 718
PSA CODE	
P 446 932 718	

Standard PSA

LIFTING COLUMN - FÜHRUNGSSÄULE FÜR HEBER - COLONNA PER SOLLEVATORE

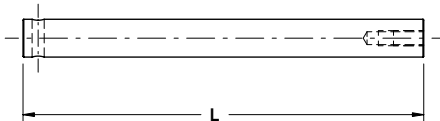
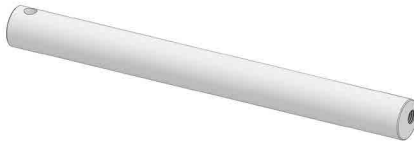

Notes	
Material: 16MnCr5 - HRC: 60÷62	



ORDER EXAMPLE	PSA CODE
	P446 940 701

PSA CODE	L
P 446 940 700	265
P 446 940 701	350
P 446 940 702	400
P 446 940 703	450
P 446 940 704	500

UNION BLOCK - BEFESTIGUNGSELEMENT - TASSELLO DI UNIONE

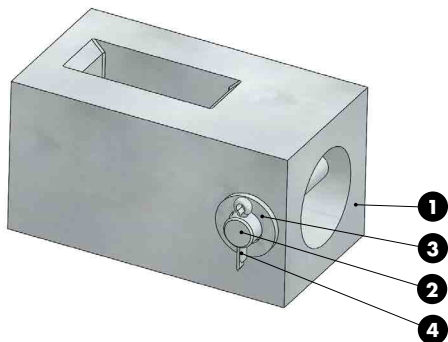

Notes

- 1 **Material:** 36NiCrMo4 - HV > 700
- 2 **Material:** CK45
- 3 DIN 126
- 4 DIN 94



	PSA CODE
	P 446 942 700
PSA CODE	
P 446 942 700	

CLEVIS - GABELFÖRMIG - FORCELLA

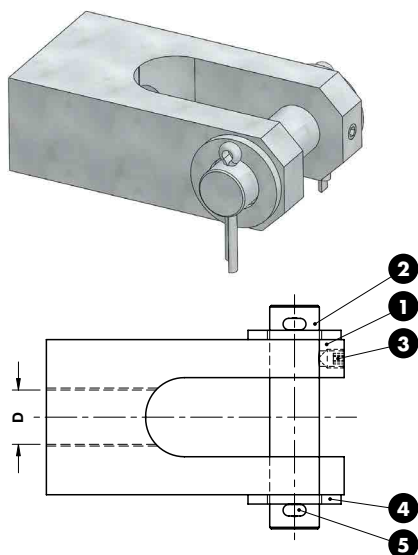

Notes

- 1 2 **Material:** CK45
- 3 DIN 914
- 4 DIN 126
- 5 DIN 94



	PSA CODE
	X 652 131 326
PSA CODE	D
Z 000 228 984	M16 x 1,5
X 652 131 326	M20 x 1,5

STAMP RETAINER - HALTEPLATTE - PORTATIMBRI

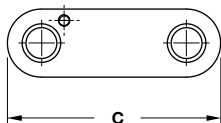
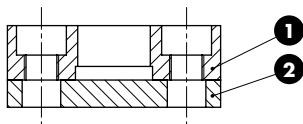
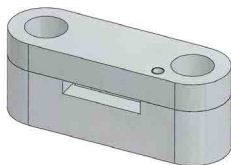

Notes

1 2 Material: CK45

STOCK



ORDER EXAMPLE	PSA CODE
	P 399 391 701

PSA CODE	C	N° of punch
P 399 391 701	47	4
N 000 467 867	55	6
P 399 391 702	63	8
P 399 391 703	71	10

Standard PSA

BACKING PLATE - DRUCK PLATTE - DISTANZIALE

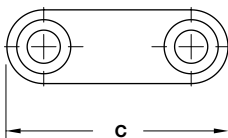
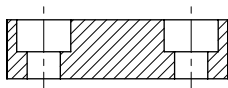
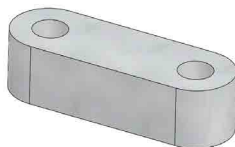

Notes

Material: CK45

STOCK



ORDER EXAMPLE	PSA CODE
	N 000 467 866

PSA CODE	C	N° of punch
Z 000 151 091	47	4
N 000 467 866	56	6
Z 000 151 092	63	8
Z 000 151 093	71	10

STAMP - BUCHSTABENSTEMPEL - PUNZONE MARCHIO

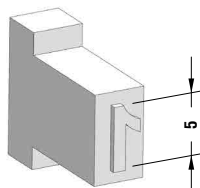

Notes

Material: X153CrMoV12
HRC: 54÷56

STOCK



PSA CODE
 P 785 150 102

PSA CODE	Stamp	PSA CODE	Stamp	PSA CODE	Stamp	PSA CODE	Stamp
P 785 150 002	0 or O	Z 000 504 318	Dash "-"	P 785 172 104	I	P 785 153 202	T
P 785 150 102	1	N 000 464 606	Dash " _ "	P 785 152 202	J	P 785 153 302	U
P 785 150 202	2	P 785 151 302	A	P 785 152 302	K	P 785 153 402	V
P 785 150 302	3	P 785 151 402	B	P 785 152 402	L	P 785 153 502	W
P 785 150 402	4	P 785 151 502	C	P 785 152 503	M	P 785 153 602	X
P 785 150 502	5	P 785 151 602	D	P 785 152 602	N	P 785 153 702	Y
P 785 150 602	6 or 9	P 785 151 702	E	P 785 152 802	P	P 785 153 802	Z
P 785 150 702	7	P 785 151 802	F	P 785 152 902	Q		
P 785 150 802	8	P 785 151 902	G	P 785 153 002	R		
P 785 289 002	Space	P 785 152 002	H	P 785 153 102	S		

STAMP - BUCHSTABENSTEMPEL - PUNZONE MARCHIO

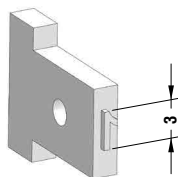

Notes

Material: X153CrMoV12
HRC: 54÷56

STOCK



PSA CODE
 Z 000 491 957

PSA CODE	Stamp	PSA CODE	Stamp	PSA CODE	Stamp	PSA CODE	Stamp
Z 000 491 893	0 or O	Z 000 504 319	Dash "-"	Z 000 491 973	I	Z 000 492 024	T
Z 000 491 957	1	N 000 467 865	Dash " _ "	Z 000 491 974	J	Z 000 492 025	U
Z 000 491 958	2	Z 000 491 965	A	Z 000 491 975	K	Z 000 492 026	V
Z 000 491 959	3	Z 000 491 966	B	Z 000 491 976	L	Z 000 492 027	W
Z 000 491 960	4	Z 000 491 967	C	Z 000 491 977	M	Z 000 492 028	X
Z 000 491 961	5	Z 000 491 968	D	Z 000 491 978	N	Z 000 492 029	Y
Z 000 491 962	6 or 9	Z 000 491 969	E	Z 000 491 979	P	Z 000 492 030	Z
Z 000 491 963	7	Z 000 491 970	F	Z 000 491 980	Q		
Z 000 491 964	8	Z 000 491 971	G	Z 000 492 022	R		
Z 000 492 408	Space	Z 000 491 972	H	Z 000 492 023	S		

STAMP RETAINER - HALTEPLATTE - PORTATIMBRI



N 001 648 906

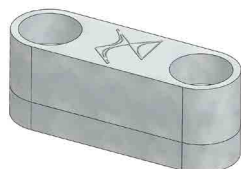

N 001 162 511

Notes

- 1 **Material:** X100CDV5-T5
HRC: 56÷58
- 2 **Material:** XC70



	PSA CODE
	N 001 162 511
PSA CODE	Punchs
N 001 648 906	Groupe PSA
N 001 162 511	DS

Standard PSA

LIFTING PIN - TRAGBOLZEN MIT FALLRINGSICHERUNG - PERNO DI SOLLEVAMENTO



Respect the max load
Maximale Nutzlast beachten
Rispettare il carico Max

WARNING - ACHTUNG - ATTENZIONE:

For safety reason, please consider always that the weight of the die has to be supported by just 2 lifting pins.

Aus Sicherheitsgründen stets berücksichtigen, dass zwei Tragbolzen das gesamte Werkzeuggewicht tragen müssen.

Per ragioni di sicurezza, considerare sempre che il peso dello stampo deve essere sopportato da 2 soli perni.

Notes

Material: St52

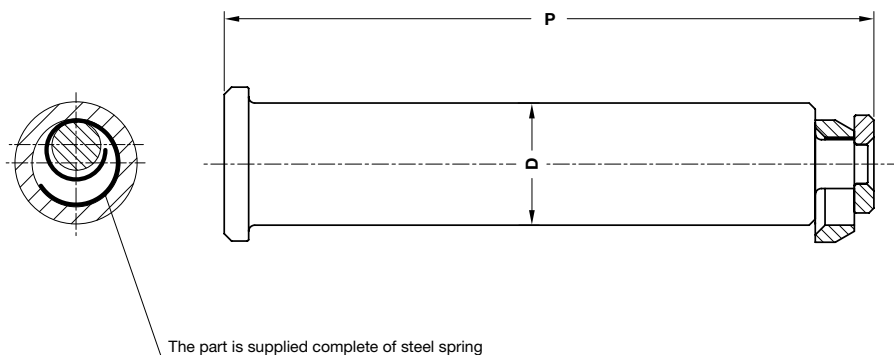

ORDER EXAMPLE 	PSA CODE
	P 953 255 870

PSA CODE	Max load (kg)	Max die weight (kg)	P	D
P 953 254 770	6000	12000	154	32
P 953 255 870	9000	18000	197,75	40
P 953 256 670	14000	28000	247,50	50
P 953 257 470	22500	45000	309	63



